

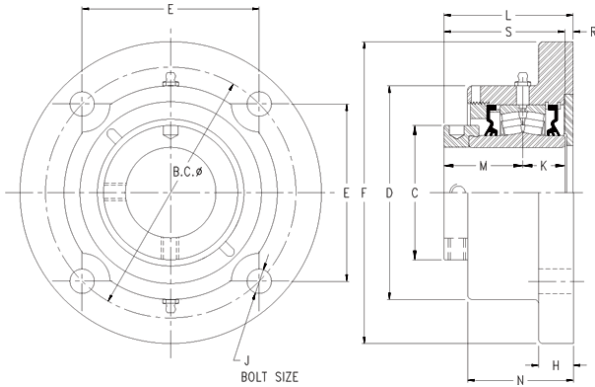

SNR BEARING CORP.OF AMERICA



timken QMFY15J075S Solid Block/Spherical Roller Bearing Housed Units-Eccentric Round Flange Block

Bearing No. QMFY15J075S

QMFY15J075S Bearing 2D drawings and 3D CAD models

Engineering Group	Mounted Bearing
Shaft Size	75 mm
Shaft Size Type	Metric
Full Timken Part Number	QMFY15J075SB
Locking Style	Eccentric
Weight	28 lb
Housing Style	Round Flange
UPC Code	0883450073622
Dimension BC	7.87 in
Dimension C	4.010 in
Dimension D	6.63 in
Dimension E	5.56 in
Dimension F	9.5 in
Dimension H	0.94 in
Dimension J (Bolt Size)	0.75 in
Dimension K	1.25 in
Dimension L Exp	3.96 in
Dimension L Fix	3.88 in
Dimension M	2.37 in
Dimension N	3.0000 in
Dimension R	0.25 in
Dimension S	3.62 in
C0 - Static Load	54100 lb
C - Dynamic Load (Basic)	49900 lb
e - Geometry Factor	0.22



SNR BEARING CORP.OF AMERICA

Y1 - Geometry Factor	3.14
Y2 - Geometry Factor	4.67
Oil Lubrication - M/N Seal	1600 rpm
Oil Lubrication - T Seal	2900 rpm
Oil Lubrication - B/C/O Seal	1300 rpm
Grease Lubrication - M/N Seal	1600 rpm
Grease Lubrication - T Seal	2400 rpm
Grease Lubrication - B/C/O Seal	1300 rpm
Float	0.083 in
Shaft Tolerance	0.0020 in
Eng Internal Radial Clearance - Min	0.0020
Eng Internal Radial Clearance - Max	0.0031
Pre Install Clearance Min	0.050 mm
Pre Install Clearance Max	0.080 mm