

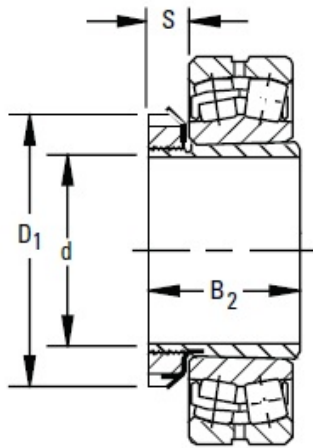

SNR BEARING CORP.OF AMERICA



timken SNW-126 x 4 1/2 SNW/SNP-Pull-Type Sleeve, Locknut, Lockwasher/Lockplate Assemblies

Bearing No. SNW-126 x 4 1/2

Series	223K and 232K
Diameter d	4 1/2 in
Taper	1:12
SNW/SNP Assembly Weight	10.1 lb
Tolerance ¹	-0.005 in
B_2	4.972 in
S	1.000 in
D_1	6.755 in
Sleeve	S-126 x 4 1/2
Locknut	AN-26
Lockwasher and Lockplates	W-26

SNW-126 x 4 1/2 Bearing 2D drawings and 3D CAD models